

RESEARCH PROJECTS IN RENEWABLE ENERGY FOR HIGH SCHOOL STUDENTS

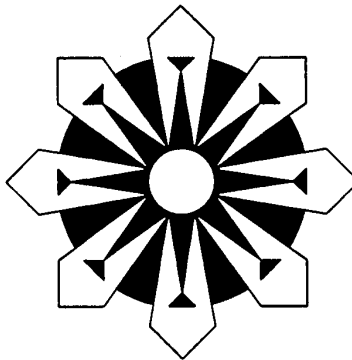

National Renewable Energy Laboratory
Education Programs
1617 Cole Blvd.
Golden, CO 80401
Tel: (303) 275-3044
Home page: <http://www.nrel.gov>



ACKNOWLEDGMENTS

The Education Office at NREL would like to thank Dr. James Schreck, Professor of Chemistry and Biochemistry, University of Northern Colorado, for his commitment and hard work in the development of this activity booklet. His expertise was invaluable in producing a final product that attempts to be "user friendly."

It is the goal of the Education Office to make these kits accessible, easy to use, and fun. We want your students to gain, not only an understanding of renewable and nonrenewable energy resources, but a greater confidence in investigating, questioning, and experimenting with scientific ideas.

If you have questions, please call the Education Office at (303) 275-3044 or e-mail:
linda_lung@nrel.gov

HOW TO USE THIS BOOKLET

The purpose of this booklet is to provide high school students with a variety of projects to broaden their knowledge of science, in particular renewable energy, and the scientific method. Projects are available in these areas of renewable energy: biofuels, wind, and solar.

Science projects described here apply the disciplines of chemistry, physics, biology, and mathematics. Below are some suggestions for effective use of this booklet:

1. First, check your EQ (energy quotient). Let your teachers grade the test you take and then decide if you need to improve your energy background. The Education Office at the National Renewable Energy Laboratory (NREL) has a small library you can use to improve your background. It is also useful for obtaining background material on an energy project described in this booklet. Contact the Education Office at NREL in Golden, Colorado at 303-275-3080 to set a time to visit the facility. It is not advisable to visit the facility without prior contact since NREL is a government facility, and your visit must be approved. Don't let that keep you away, however; the Education Office staff is happy to help you if they can.
2. Read the section on "How to do a Science Project."
3. Decide if you want to do a technical report or a hands-on activity research project in the area of biofuels, wind energy, or solar energy.
4. Choose a project, and discuss it with your teachers. You will likely need an area in your laboratory for a period of time. Your teacher will help you with the availability of equipment and materials.
5. Use the Idea for Study to decide on a project. In many cases, suggestions are made for the study. Don't attempt every possible angle (variable); don't try to answer every question. Discuss your progress on a routine basis with your teachers. Often those not directly involved with the project have insight and suggestions that are worthwhile considering.
6. Keep in mind that the length of time spent on the project is not indicative of the quality of the work. A research project always provides the answer to the original question and raises one or two more questions for future study.
7. Keep a research notebook, and write in your notebook on a routine basis. When you complete your project, the notebook entries can be used to write the report.
8. Be sure to communicate your results with others through the research report and/or a poster display.

GOOD LUCK!

WHAT' S YOUR ENERGY QUOTIENT?

Pretest on Energy Principles

I. Check those statements that describe energy:

- leaves moving in the wind
- a pot of boiling water
- driving a car to school
- finding your way in the dark with a flashlight
- burning gas in a furnace
- grilling a steak

2. What does the phrase "I don't have much energy today" mean to you?

3. What do you think the phrase "energy source" means?

4. Make a list of as many energy sources as you can think of.

5. Energy sources can be placed in two categories: renewable and nonrenewable. How do you think these two energy sources differ from each other?

6. Look at your list of energy sources in question 4, and label them as renewable or nonrenewable.

7. In contrast to nonrenewable, renewable energy sources produce little or no pollution or hazardous wastes, pose few risks to public safety, and are entirely domestic resources. Explain why you agree or disagree with this statement.

8. Energy sources are used mainly to produce electricity--a more useful energy source. Choose any energy source you listed in question 4, and describe how this is accomplished.

9. Why is it important not to waste energy? As a citizen, how to you conserve energy?

10. Assume all the reserves of nonrenewable energy sources have been depleted. How do you think people will light and heat buildings, and what will they use for transportation?

HOW TO DO A SCIENCE PROJECT

The scientific method is a pattern of inquiry that forms a structure for advancing scientific understanding. By identifying a problem, forming a hypothesis, designing and conducting an experiment, taking data, and analyzing the results, scientists have answered questions ranging from the simplest to the most complex. Yet the process can be broken down into several distinct steps.

We've tried to be quite explicit in outlining the steps of the process. And we believe doing all the steps is appropriate for the student doing an individual project—either as a classroom project or for a competitive fair. On the other hand, teachers doing projects in the classroom might choose to skip some of the steps, depending on the level of the students and the time available.

1. Identify an area of interest

- Decide what area of science is of interest e.g., physics, biology, chemistry, or engineering.
- Narrow the area of interest so that it is more specific, e.g., solar energy, plants, or animals.



2. Gather information

Our knowledge of the world results from ideas and observations made by us and by others. Many of these observations are recorded in such scientific literature as scientific journals, government documents, periodicals, and books.

- Search for information in the area of interest in the library.
- Begin in an organized manner by using reference material such as the *Reader's Guide* or the card catalog.
- Keep in mind that most Scientific journals publish information pertaining to a single field of Science. For example, *the American Journal of Physics* and *the American Journal of Botany* relate to

specific topics. On the other hand, some periodicals, such as *Scientific American* and *Science*, cover a range of scientific issues.



- Make sure to record the author(s), titles of the article and the journal, title page numbers, and pertinent publishing information for every reference used. (Recording this information on note cards is helpful.)

3. Select a specific problem within the area of interest

It is important to narrow the research area to a specific problem. One common error is to try to do too much. (This process would be repeated as more information is gathered.)

4. Gather more information

It may be necessary to return to the library and look for information that deals **directly** with the specific topic. Look for ideas that may help in the experimental design or for ideas that complement the topic.

5. Plan an investigation or an experiment

Keep these things in mind when designing the experiment:

- Are the variables appropriate?
- Are the variables independent?
- Are the variables measurable?
- What kind of controls will be included?
- What data will be collected?
- Is the experiment designed appropriately if the results are to be analyzed statistically?
- Are the materials and equipment available?
- Are there some special safety or environmental concerns?

If the project uses mathematical or computer modeling instead of experimentation, how will the results be validated? Is there a way to test the model?



When the approach to the experiment is clear it's time to write a proposal. The proposal should describe the experiment in detail, including required materials and

equipment, any safety concerns, and expected results. It will allow the teacher or the science fair review committee to evaluate the appropriateness of the project.

Include the following in the proposal:

- Background information: A review of the literature summarizing information related to the project. Be sure to cite all references.
- Purpose and hypothesis: A brief description of the purpose of the project and a statement of the hypothesis.
- Experimental design: A detailed explanation of the research plan and the materials needed is included in this section. The methods and materials should be described in a way that anyone could duplicate the experiment(s).
- Literature cited and references: Include a list of all authors cited and a list of supplemental references.

6. Obtain approval of the proposal from the teacher or science fair review committee



7. Conduct the experiment(s) and collect data

- Record the data in a notebook. Record the data immediately, completely, and accurately. (It is better to record too much data than not enough.)

- Record other observations about the experiment in a notebook. e.g., describe progress, take pictures, make sketches. Are some things not going according to plan? Are there any surprises? These observations may be important later.

8. Organize and report the results



Most data involve numbers and can be quantified. Therefore, using statistics, graphs, tables, and charts are appropriate. Remember, this is the portion of the research on which conclusions are based. The better this portion is presented, the easier it is to formulate conclusions. Data should be presented:

- in written form with graphs, tables, and charts
- without conclusions or value judgments

9. Analyze and discuss the results

Think about the results. What do they mean? How should they be interpreted? By discussing various aspects of the experiment and observations, provide additional context for the results shown by the data. Look for patterns, relationships and correlations.



10. Formulate conclusions

Was the hypothesis supported? This is an important step and must emphasize what has been learned from doing the project. Conclusion statements must be supported by data collected and related directly to the purpose and hypothesis.

11. Assess the project

Did the experiment go as planned? If so, were there other interesting aspects that deserve follow-up

research? If the experiment did not go as planned, why not? Was the hypothesis too broad? Was the experimental design inappropriate?

If the hypothesis was not confirmed, what was learned? Answers to all these questions can help form recommendations for further research.



12. Write the final report

The final report, whether it is to be presented orally or in written form, should include the following:

- Title
 - should be self-explanatory, i.e. the reader should be able to tell what the research is about without reading the paper.
- Abstract
 - a brief condensation of the entire report, 150 to 250 words for advanced students; shorter for students in lower grade levels.
 - includes the purpose, very brief explanation of methods, and conclusions.
- Introduction
 - contains background information with cited references, statement of the problem or purpose.
- Methods and Materials
 - contains an explanation of how the work was done (experimental design)
 - describes materials -what? -how used?
 - is stated briefly and clearly so that others could repeat the experiments.
- Results
 - includes a written explanation of the data in a straight forward manner with no conclusions or judgment statements
 - uses tables, graphs, pictures, and other types of data where appropriate
- Discussion
 - explains what the results mean
 - describes patterns, relationships, and correlations.

- Conclusions
 - presents the important conclusions that the reader needs to know
 - includes a discussion of problems encountered and recommendations for further research.
- Literature Cited
 - lists alphabetically by author all published information referred to in the text of the paper. Other references can be used and referred to in a bibliography. (See examples in the Resources section of this book for proper form.)
- Acknowledgments
 - lists and gives credit to people who were helpful in providing materials and equipment or ideas.

13. Present the results orally

If this is a project for the classroom, make an oral presentation about the work to the class. If the project is for a science fair, prepare a display (see science fair officials for details) and prepare to discuss the project with the judges. In either case, be prepared to:

- be knowledgeable about the project
- practice the presentation before others
- talk clearly
- act interested
- dress neatly.



How to do a Science Project

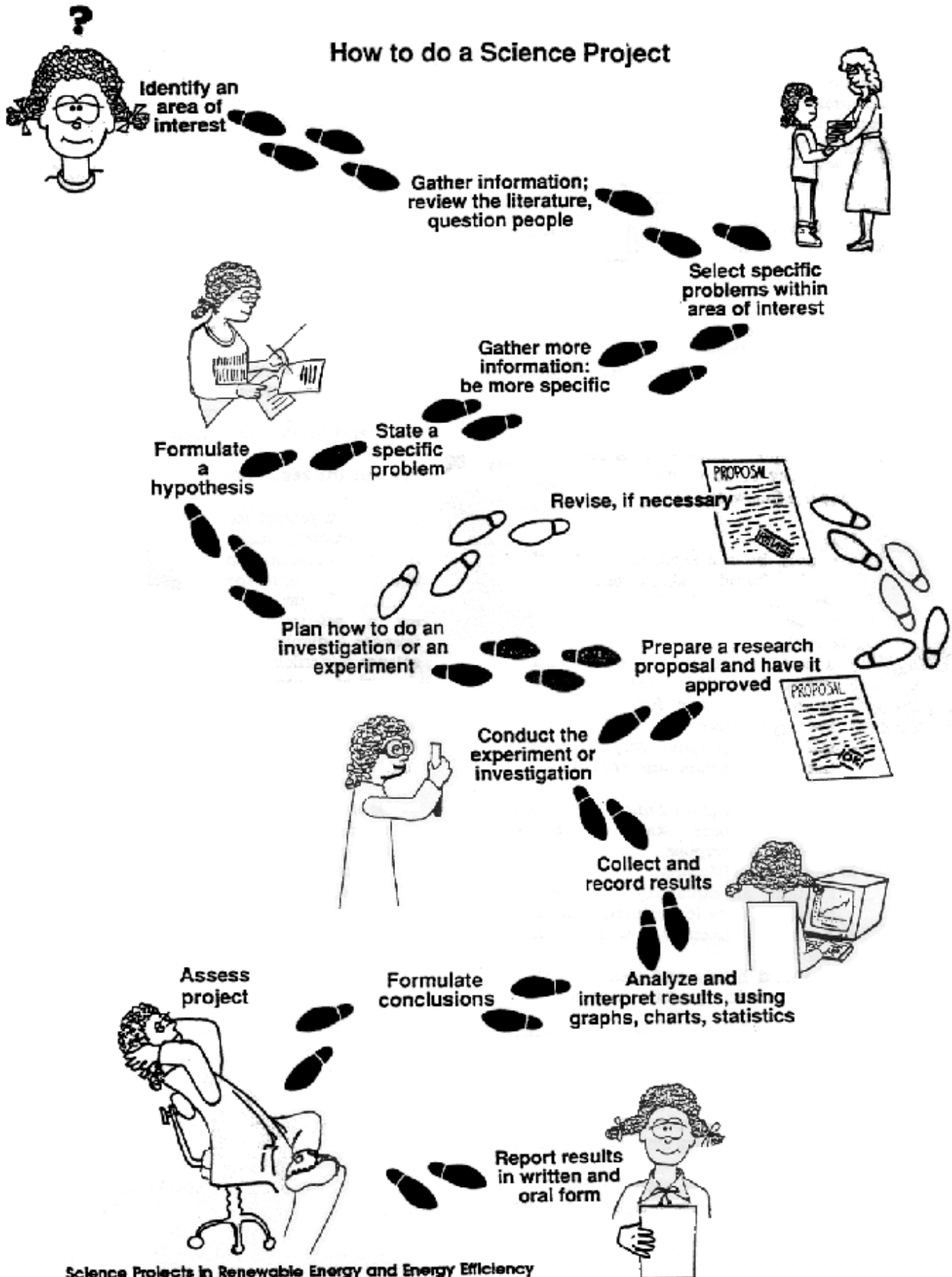

TECHNICAL REPORT

Preparing a science report that does not involve hands-on activities is a very important and worthwhile endeavor. Some students enjoy science, but don't find laboratory activities fun and exciting. Similarly, other students enjoy hands-on activities, but don't enjoy the task of writing about their results. However, both tasks (doing science and writing about science) are important to both scientists and citizens, and neither is more useful than the other. It is a matter of personal choice.

The research report suggested here is for students who would prefer to write a technical, scientific report. However, this project involves more than just writing. As such it involves the following tasks:

- topic research
- report preparation
- photography
- art
- technical display

It could easily be a group project that would culminate in a written report and poster display. The task is to prepare a report based on the concept map in Appendix 1. This energy concept map categorizes some of the important aspects of energy. The task is to research and describe the following facets of each category. The suggested questions in each category below are designed to help you with ideas that are important in a discussion of the category, and should be incorporated in your report.

- **WHAT IS ENERGY?** Define and describe energy. Distinguish between potential and kinetic energy and give examples of each. What is the Law of Conservation of Energy. Why is it significant to know that when energy is transformed it is conserved in quantity but not in quality? What is the primary energy transformation for most energy resources? What effect does using energy have on citizens' lives? What is energy conservation and why should citizens conserve energy? In what way(s) does energy use impact the environment?
- **ENERGY FLOW.** How does the flow of energy from the sun affect wind and water cycles? How does sunlight help plants trap energy? How does the energy in plants get passed along through the food chain? How do humans utilize this energy?
- **HISTORIC RESOURCES.** Describe the manner in which these resources are used for energy? Define renewable and nonrenewable energy resources and categorize each of the ones listed here as renewable and nonrenewable. How much is used each day and for what purpose? Are all these resources available in your state? How much? What are the pros and cons of each as an energy resource?
- **ENERGY ALTERNATIVES.** Describe each of these and give pros and cons about each. Which are renewable and nonrenewable? Are all alternatives available in your state? What environmental impact would these energy resources have?

Ideas to Study

1. Prepare a poster display. You will need to write a brief overview (called an abstract) of your report by section. You might work with a group and have someone take or obtain 3-4 photographs relating to ideas of each section (for example, you could illustrate potential versus kinetic energy by having a photograph of your team's quarterback before the ball is snapped, and then another as the ball is released for a pass). You might work with a friend from the school newspaper or yearbook staff interested in page layout and technical display.

2. Prepare a shorter version of your report to be published in the school newspaper.
3. Give an oral presentation (with slides or overhead transparencies) to a science class in your school.
or to a middle school classroom that you have permission to visit.

Doing science in this manner can be satisfying and rewarding. Technical reports are numerous on TV and in the newsprint. Maybe someday you will have written the paragraph read by your favorite TV newscaster or reported in Time and Newsweek magazines on the yet to be discovered fourth state of matter.

Energy Resources Concept Map

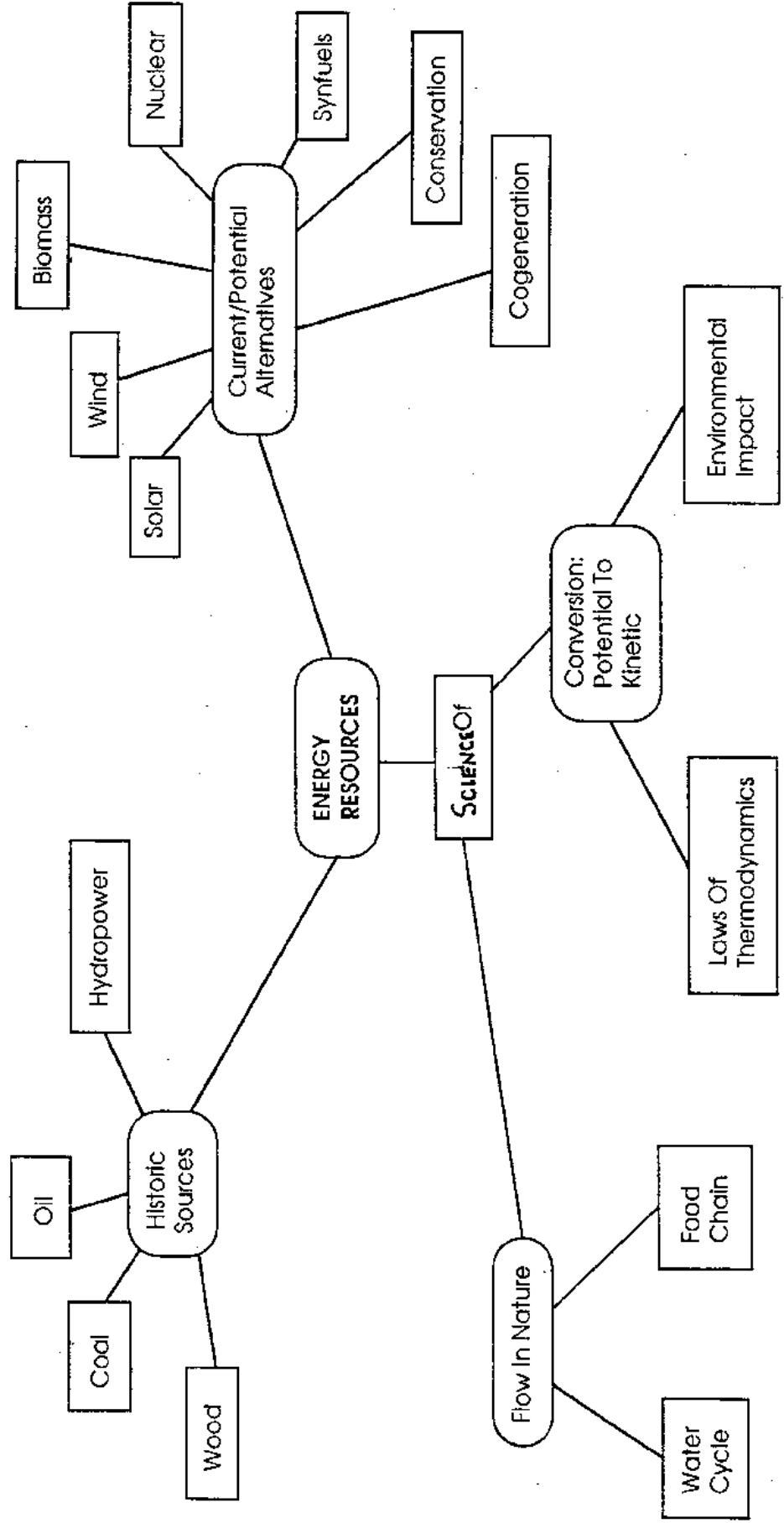

BIOFUELS

Project #1: What is the efficiency of ethanol production from various sources?

Project #2: What kind of biomass is best for producing methane gas?

Project #3: What kinds of plants have the most heat energy in a given quantity of biomass?

Project #4: How much energy can be obtained from alcohol fuels?

Project #5: What factors affect biomass growth?

BIOFUELS

Biofuels are produced from biomass. Biomass includes living organisms such as plants, trees and crops, as well as half of all trash. The major potential of biomass is for production of liquid transportation fuels. These fuels include ethanol and methanol, two alcohol fuels made from corn, wheat and other crops, and methane, a colorless, odorless and flammable gas made from waste. Ethanol, methanol and methane offer an attractive alternative to petroleum-based gasoline and diesel fuels.

There are more than 185 million vehicles in the U.S., and these vehicles are responsible for two-thirds of the nation's total oil consumption. The quantity of biomass currently available could produce enough liquid transportation fuel to replace all the gasoline we currently use in these vehicles. By the end of the decade, technological advancements will make these fuels as affordable and easy to use as today's petroleum-based gasoline and diesel fuels.

PROJECT #1 WHAT IS THE EFFICIENCY OF ETHANOL PRODUCTION FROM VARIOUS SOURCES?

Reference A procedure for preparing ethanol is given in many organic chemistry laboratory manuals. For example, see Pavia *et al.* *Introduction to Organic Laboratory Techniques*, Saunders College Publishing, 3rd ed., 1988 "Ethanol from Sucrose," p.84.

Ideas for Study

1. Compare the relative yields of ethanol produced from various sources: table sugar, grain crops, fruits, cellulose, corncobs, corn silage, etc. One way to do this is to use rate or total volume of carbon dioxide production as an indirect indicator of ethanol production. For a more accurate measurement, contact the chemistry department at a college/university to see if someone would let you use a gas chromatography unit. Demonstrate the energy of the distillate fuel by soaking it in cotton wool and setting it alight. Don't forget to run a control.

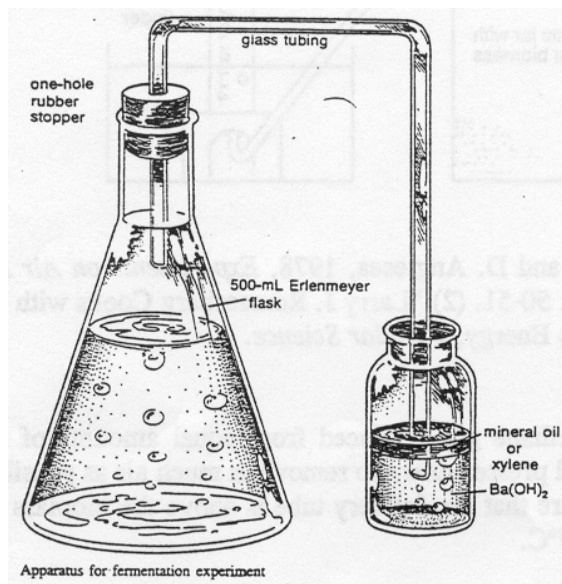

2. Develop a procedure for determining the percentage of alcohol you can prepare from the various sources. One method might be to use potassium dichromate standards. This substance is the basis for some commercial kits for determining alcohol levels before and after consuming alcoholic beverages.
3. Investigate optimum temperature for fermentation.
4. Investigate aerobic and anaerobic conditions for producing ethanol.
5. Investigate methods of quantifying ethanol production from one or more sources.

PROJECT #2 WHAT KIND OF BIOMASS IS BEST FOR PRODUCING METHANE GAS?

Caution Methane gas is explosive when mixed with air! Extreme care must be taken when generating large quantities of methane. Don't attempt this project in a laboratory or home basement if flames from a laboratory burner or furnace are around. Be sure to purge the system of air before attempting to burn methane!

Materials Source of biomass (e.g. animal dung, garbage, food wastes, etc.).

Equipment Methane generator as shown below.

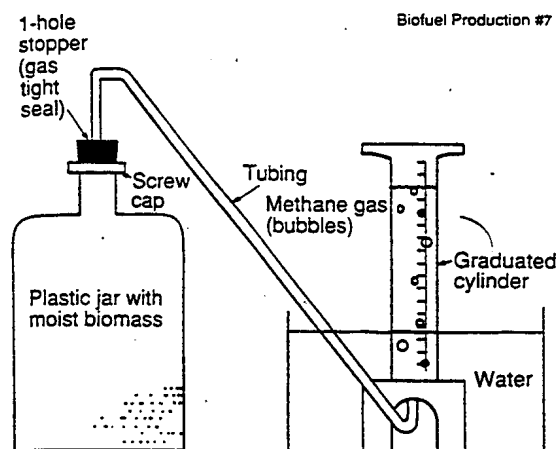

Resources (1) Williams, D.I. and D. Anglesea, 1978, *Experiments on Air Pollution*, Hove, England: Wayland Publishers Limited, p. 50-51. (2) "Larry J. Romeesberg Cooks with Bio-gas." December 1975, from *Adventures in Alternative Energy*, *Popular Science*.

Ideas to Study

1. Compare the volume of methane gas produced from equal amounts of biomass. Fill the jar with biomass and make sure it is well pressed down to remove as much air as possible. Biomass must be moist (add water if necessary). Be sure that the delivery tube is above the biomass in the generator. The best incubation temperature is 36-37°C.
2. Investigate the effects of temperature on methane generation. **CAUTION:** do not use a laboratory burner of any type to raise the temperature of the contents in the jar. To raise or lower the temperature,

place a pan of hot or ice cold water beneath the gas generator. You may need to devise a safe way to keep the temperature warmer or colder than the optimum temperature.

PROJECT #3 WHAT KINDS OF PLANTS HAVE THE MOST HEAT ENERGY IN A GIVEN QUANTITY OF BIOMASS?

Equipment Laboratory balance and a calorimeter (see diagram below):

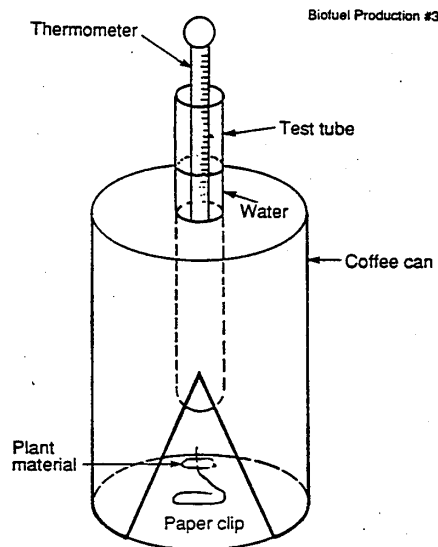

Safety Work in a well-ventilated area. Be extremely careful of burns because a lot of heat energy will be generated.

Reference A college level general chemistry text will have a chapter on thermochemistry that will be useful in seeing some of the calculations needed to do in this project.

Ideas for Study

1. Conduct preliminary tests to determine the best size of plant material to test. Compare the heat energy in a given quantity of plant materials (e.g., peanuts, pecans, walnuts, castor beans, sunflowers, corn, and milkweed). Calculate the amount of calories per gram. Use equal volumes of water in the test tube for each test and record the beginning and ending temperatures.
2. You can improve your results by using a bomb calorimeter. Check with the chemistry department at a college or university.
3. Determine the usable heat energy that could be produced on an acre of land if certain crops were raised. Choose peanuts and sunflowers, for example. This would require one to know the caloric value (cal/g) and the amount of biomass produced per unit area.
4. Devise a procedure for extracting the oil from the plant and determine the oil's heat energy. For example, milkweed contains latex, an unsaturated hydrocarbon.

PROJECT #4 HOW MUCH ENERGY CAN BE OBTAINED FROM ALCOHOL FUELS?

Materials Use the set up for the calorimeter as described in Project #3, but use an alcohol burner as the source of heat.

Caution Alcohols are very flammable. Work in the science laboratory under supervision of your teacher or another adult.

Ideas for Study

1. Compare the heat energy from burning alcohols (e.g., methanol, ethanol, propanol, rubbing alcohol, etc). Measure the weight of alcohol before and after the burning alcohol raises the temperature of 100 mL (equals 100 g) of water at least SOOC. Calculate the calories per gram for each alcohol tested.
2. Devise a more efficient procedure that reduces heat loss. Determination of heat values and efficiencies as related to cost would be important to know. How could these fuels be used?

PROJECT #5 WHAT FACTORS AFFECT BIOMASS GROWTH?

Caution Handle fertilizers, pesticides, and plant hormones with care.

Procedure Grow plants from seeds in cups or pots. Measure height and width daily or measure dry weight after several days or weeks. Use a variety of plant types -food and nonfood, grasses, and weeds. Weigh soil to see how much "earth" is used.

Ideas to Study

1. Investigate plant growth utilizing one of these factors. *Keep in mind each factor can be a study in itself:*

- a. Type of light.
- b. Amount of light.
- c. Spacing of seedlings.
- d. Soil type.
- e. Frequency of watering.
- f. Fertilizer vs. no fertilizer.
- g. Pesticide vs. no pesticide.
- h. Salt content of water [use varying concentrations of salt water and measure dry weight after days or weeks].
- i. Plant hormone vs. no plant hormone. [Apply plant hormone with aspirator or a perfume bottle or small paint brush, but apply evenly. Biomass can be determined as fresh weight and dry weight (dry in oven) for 24 hrs at 90°C -include roots.]

j. Orientation of a single seed when planted. [Replicate the orientation of seeds planted several times. Remember the greater the sample size the more reliable the data. Plant each seed at the same depth as the others. Make sure that the light source is equally distributed on each tray containing the seeds.]

k. Depth seed is planted in soil.

l. Effect of increased amount of carbon dioxide (see diagram below and handle dry ice with care). [plants should have a minimum of 5-6 leaves and be of approximately equal size. Calculate total leaf at the beginning and end of the experiment for each plant. If dry ice is used, consider that carbon dioxide is heavier than air and also consider the temperature effect on plants. Use same soil provide equal amounts of water and light. Could use sodium bicarbonate and monitor pH.]

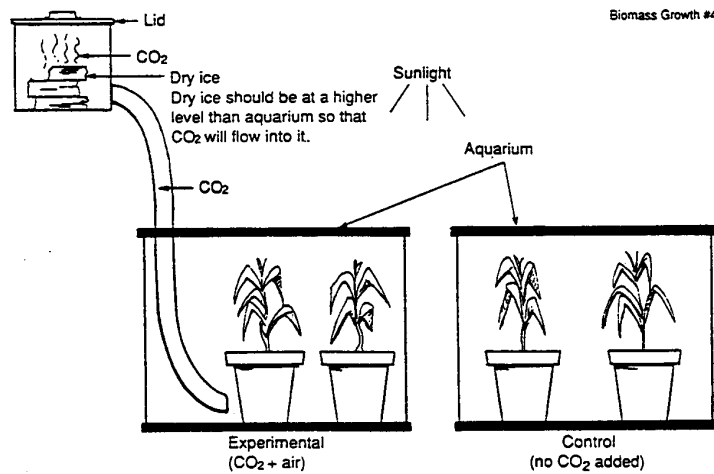

m. Effect of temperature on the rate of photosynthesis [Assemble the apparatus as shown in the diagram below and take care assembling the apparatus, specifically the insertion of a glass tube into a rubber stopper. Be careful of the hypodermic syringe. Many general biology lab manuals give directions for measuring gas production in photosynthesis. Don't forget to set up a control (minus the plant). Keep light intensity the same and remember that most light sources produce heat.

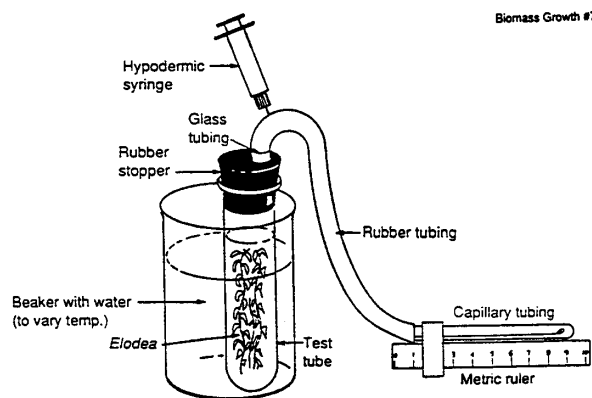

WIND ENERGY

Project #1: What techniques can be used to measure and compare wind direction and speed?

Project #2: How does a wind propeller affect how much electricity it produces?

Project #3: What is the most efficient spacing of wind turbines for “farming” wind in a given unit of space?

WIND ENERGY

The Earth's winds contain vast amounts of energy. People have harnessed this energy for thousands of years to sail ships, grind grain and pump water. Today, advanced wind turbines offer an efficient means of capturing wind energy and using it to produce electricity. Wind turbines are used for individual homes and also grouped together in wind farms to generate electricity for utility grids. Wind turbines have two or three long, light-weight blades that turn quickly. The longer the blade and the greater the wind speed, the more electricity generated. Steady wind speeds of no less than 12 miles per hour year round are required to effectively generate electricity.

CAUTION: Take precautions when working with fans and electricity.

PROJECT #1 WHAT TECHNIQUES CAN BE USED TO MEASURE AND COMPARE WIND DIRECTION AND SPEED?

Materials Beaufort Wind Scale (see Appendix 1), wind vane, and anemometer. Calibrate vane with a compass and calibrate the anemometer through the window of a car.

Resource *Bulletin of the American Meteorological Society*, May 1989. Vol. 70, No.5, p.490-508.

Ideas to Study

1. Compare the Beaufort Wind Scale to the wind vane and anemometer for measuring wind direction and speed at a specific site for a determined time period (e.g., morning, noon, and afternoon or evening for a six week period of time). At what time of day do the fastest winds usually occur? Which method is more reliable and why?
2. Compare the design of the wind vane and/or anemometer for efficiency at a specific site over a period of time.
3. Compare different sites for collecting wind energy using the wind vane and/or anemometer for a given period of time.
4. Determine how the topography affects the results in one of the studies above.
5. Determine how the height of the device (wind vane or anemometer) affects the results in one of the studies?
6. Make a map of measured wind versus location, time of year, and time of day.

PROJECT #2 HOW DOES A WIND PROPELLER AFFECT HOW MUCH ELECTRICITY IT PRODUCES?

Materials Fan (2-3 speeds) or hair blower, a 1.5 v dc motor, voltmeter (0-5 v), a 100-ohm resistor, and insulated wire that is typically available from your Physics instructor. Propellers (model airplane from a hobby shop or see Appendix 2 for building three different wind propellers) .You should also design and build your own wind propeller. See sketch for experimental set up. You might want to do your study in a wind tunnel, which you can make from cardboard.

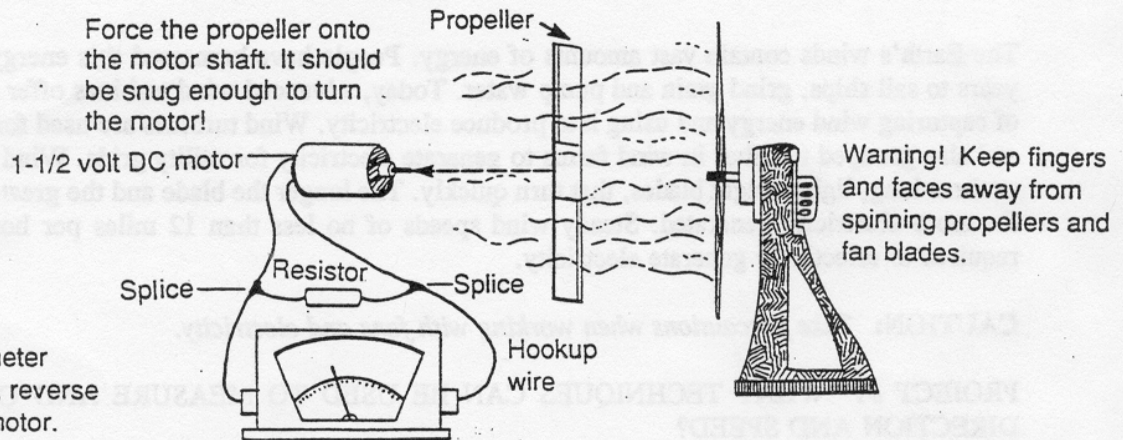

Ideas to Study

1. Compare the blade angles and how the propeller spins. Attach Model 1 to the motor shaft. Tilt the blades so that they are perpendicular to the end of the cork (Figure A). Place the wind machine in front of a working fan (or a hair blower). If the propeller doesn't spin, slightly rotate the blades so that they are at a small slant (Figure B). Place the propeller in front of the fan or hair blower. Keep tilting the blades in small increments until the propeller starts spinning. When this happens, measure the voltage produced. Keep tilting the blades of the propeller to see which angle produces the greatest voltage. Deduce if the speed of the blades varies with the angle between wind direction and blade. How might the material from which the blade is made (paper, stock paper, plastic, etc.) affect the propeller spin? How might the number of blades (1,2,3,etc.) affect the spin of the propeller?

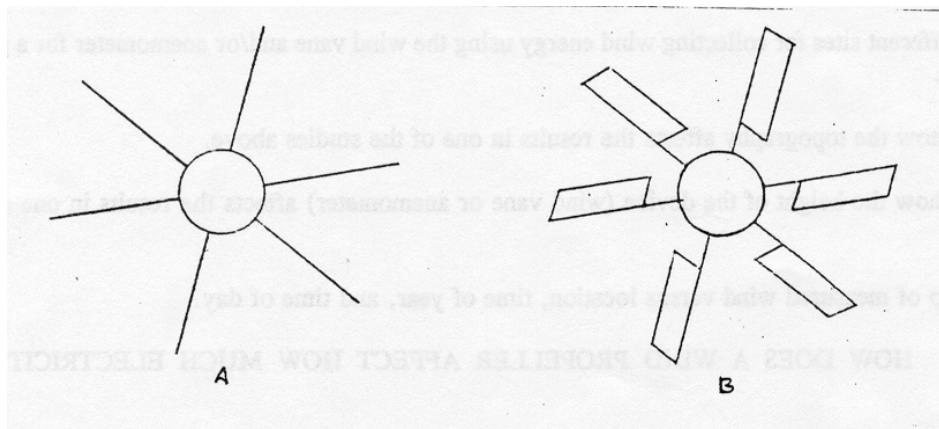

2. Compare the size of the wind blades with how fast a propeller can turn. Keep the wind blade on Model 1 at the angle at which they produced the greatest voltage. Measure the voltage. Then, attach Model 2 wind propeller to the motor shaft, with the blades at the same angle. Put it in front of the fan or hair blower at the same distance as you did with the first propeller (Why?). Measure the voltage by this wind turbine. Repeat for the other models. Determine if the amount of energy derived from the wind varies with the area swept by the blades or the size of the blades (diameter of the wheel).

3. Compare the shape of the propeller blades and how fast they can spin. Keep the wind blades on Models 1 and 2 at the same angle as in the previous study. Measure the voltage again. Then attach Model 3 wind propeller to the motor shaft, with the blades at the same angle as the Models 1 and 2 wind propellers? Measure the voltage. Repeat with the wind propeller you designed, and measure the voltage. Deduce if the shape of the blades in a wind propeller determine the efficiency of conversion.

4. Compare how wind speed affects the electricity output of wind machines. Use any of the propellers, and place the wind machine in front of a two-speed fan. Turn fan on low speed. Measure voltage. Then turn fan of high speed and repeat measurement. Determine if there is a mathematical relationship between the energy derived from the wind and the wind speed. Deduce how concentrating the wind speed through a cone affects the electricity output.

5. Alter any of the wind turbines such that it is strong enough to power a flashlight bulb (average voltage 2.5 volts). Were any of the models you used here strong enough?

PROJECT #3 WHAT IS THE MOST EFFICIENT SPACING OF WIND TURBINES FOR "FARMING" WIND IN A GIVEN UNIT OF SPACE?

Procedure Set up each turbine as illustrated in Project #2 and below. A simple wind tunnel could be constructed of cardboard to decrease variations of airflow generated by a fan.

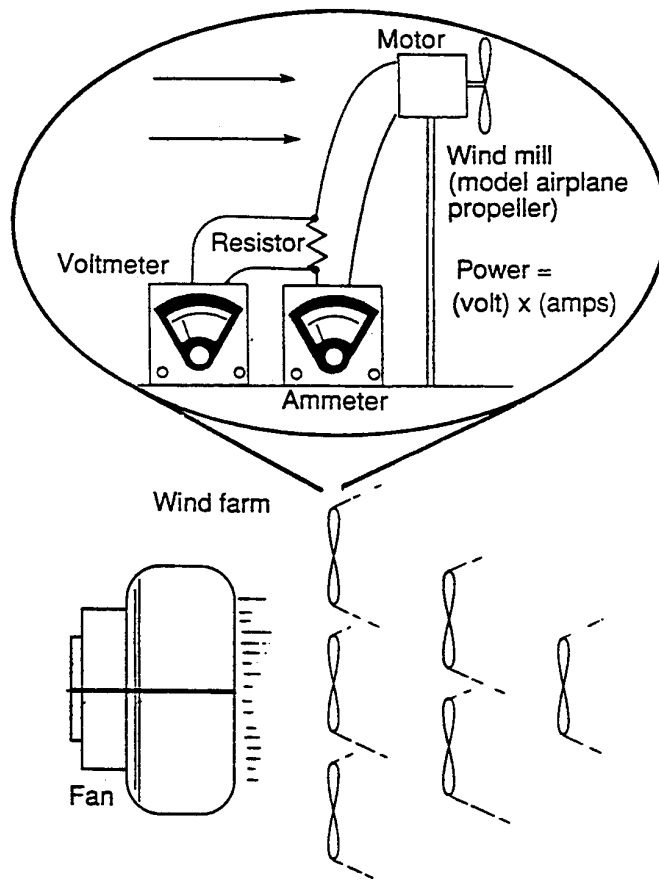

Ideas to Study

1. Determine total electricity produced for a model land area and then calculate the total electricity produced for a larger area by extrapolation.
2. Compare the total electricity produced using variables such as wind direction, topography, and number and design of the wind turbines.

PROJECT #4 IS A VERTICAL WIND TURBINE MORE EFFICIENT THAN A HORIZONTAL WIND TURBINE?

Definition A vertical wind turbine is one that looks like a giant eggbeater; a horizontal wind turbine is one with blades like airplane propellers. Projects 1-3 involved horizontal wind turbines.

Procedure Construct a vertical wind turbine (see Appendix 3) and then turn your model into a wind generator, by using a ring stand and clamps to support the wind turbine (see below). Attach the bottom end of the shaft (coat hanger) to the shaft on the small motor. Connect wires from motor to voltmeter.

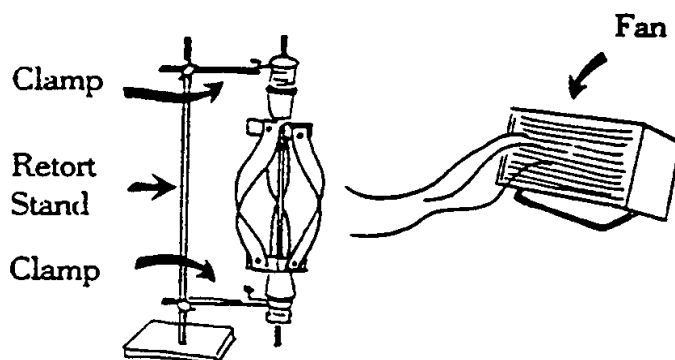

Ideas to Study

1. Determine efficiency of the vertical wind turbine and compare it to the horizontal wind turbines from Project #2. How does the efficiency compare in moderate winds (low fan speeds) and high winds (high fan speeds)? Position the fan in front and then to the side of the turbine. Deduce if there is a loss, gain or no change in efficiency.

BEAUFORT WIND SCALE

This is the Beaufort Wind Scale. It is to measure wind speeds. It relies on human observations, no mechanical devices, to calculate the speed of the wind.

BEAUFORT NUMBER	DESCRIPTION	OBSERVATION
0	calm (0-1 mph)	smoke rises vertically
1	light air (2-3 mph)	smoke drifts slowly
2	slight breeze (4-7 mph)	leaves rustle; windvane moves
3	gentle breeze (8-12 mph)	twigs move; flags extended
4	moderate breeze (13-18 mph)	branches move; dust and paper rise
5	fresh breeze (19-24 mph)	small trees sway
6	strong breeze (25-31 mph)	large branches sway; wires whistle
7	moderate gale (32-38 mph)	trees in motion; walking difficult
8	fresh gale (39-46 mph)	twigs break off trees
9	strong gale ((47-54 mph)	branches break; roofs damaged
10	whole gale (55-63 mph)	trees snap; damage evident
11	storm (64-72 mph)	widespread damage
12	hurricane (73-82 mph)	extreme damage

WIND MACHINE INSTRUCTIONS

This sheet tells you how to build your own wind machine for generating electricity.

First, get a small motor and a ruler or piece of wood from your teacher. Attach the motor to the end of the ruler by wrapping it with a rubber band.

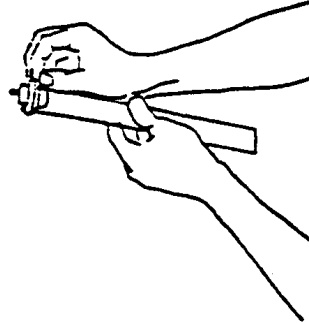
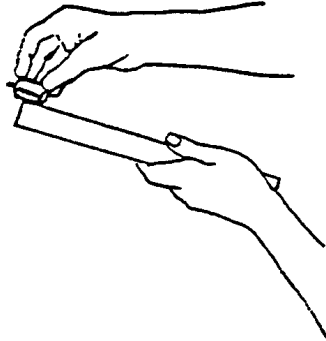

Second, cut two 30-cm pieces of electrical connecting wire. With a pair of scissors, take off 2 cm of rubber insulation from both ends of the two wires. Do this by pinching softly with the scissors on the rubber casing, cutting it slightly; then pull the scissors towards the wire's end, pulling off the casing.

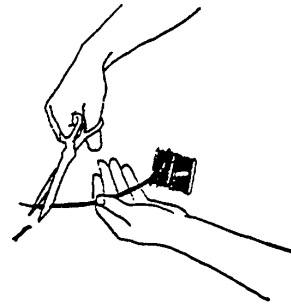

Next, attach one end of each wire to one of the motor's outlets. Tape the wires to the molding, at the end without the motor. Attach the other two ends of the wire to a voltmeter.

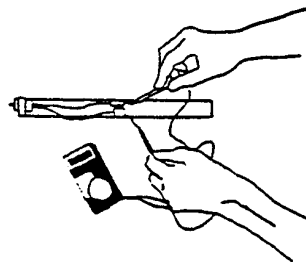
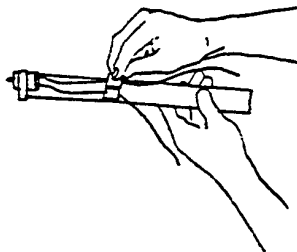

Now you're ready to build the actual wind propellers. There are three models you'll need to build.

WIND MACHINE INSTRUCTIONS (cont.)

MODEL 1: Take six paper clips. Snip off part of each clip with pliers or wire cutters. Straighten out the bottom part of each clip.



Then cut out six pieces of cardboard 1 cm x 3 cm. Glue / or tape central part of each paper clip to the bottom of a cardboard piece. Leave time for glue to dry (20 min.).



Take a cork and poke the six wind blades into it. Insert the blades at about 5 mm from the end, spaced equally around the circumference of the cork. To loosen up a hole, you may want to stick a pin in beforehand.

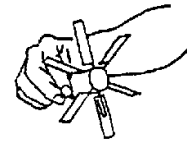

MODEL 2: Follow the same directions as in Model 1, but this time cut cardboard rectangles that are 1-1/2 cm x 4 cm.

MODEL 3: Follow same directions as Model 1, but this time cut cardboard in the following shape:
(Note: This: *shape has the same surface area as Model 2*)

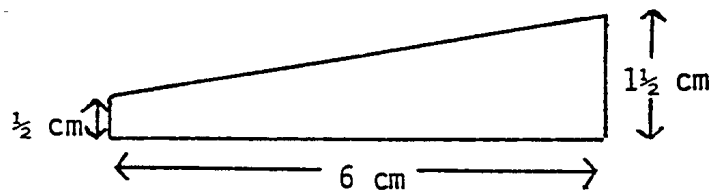

To use a wind propeller, place the cork end furthest away from the wind blades on the motor's shaft. Make sure the shaft goes in the exact center of the cork and do not wiggle it (this will loosen its hold on the motor).

CONSTRUCTION OF A VERTICAL WIND TURBINE

Materials

- 2 cotton reels
- 1 piece 12.5 mm balsa (5 cm x 10 cm) or stiff cardboard and cut out triangle shape with folded edges
- Stanley (utility) knife/scissors
- 1-1/2 to 6v DC motor
- electrical tape
- 2 electrical wires w/ alligator clips
- 1 pair pliers
- retort stand w/ 2 boss-heads and 2 clamps

NOTE: Carefully examine the following diagrams before beginning construction of you model.

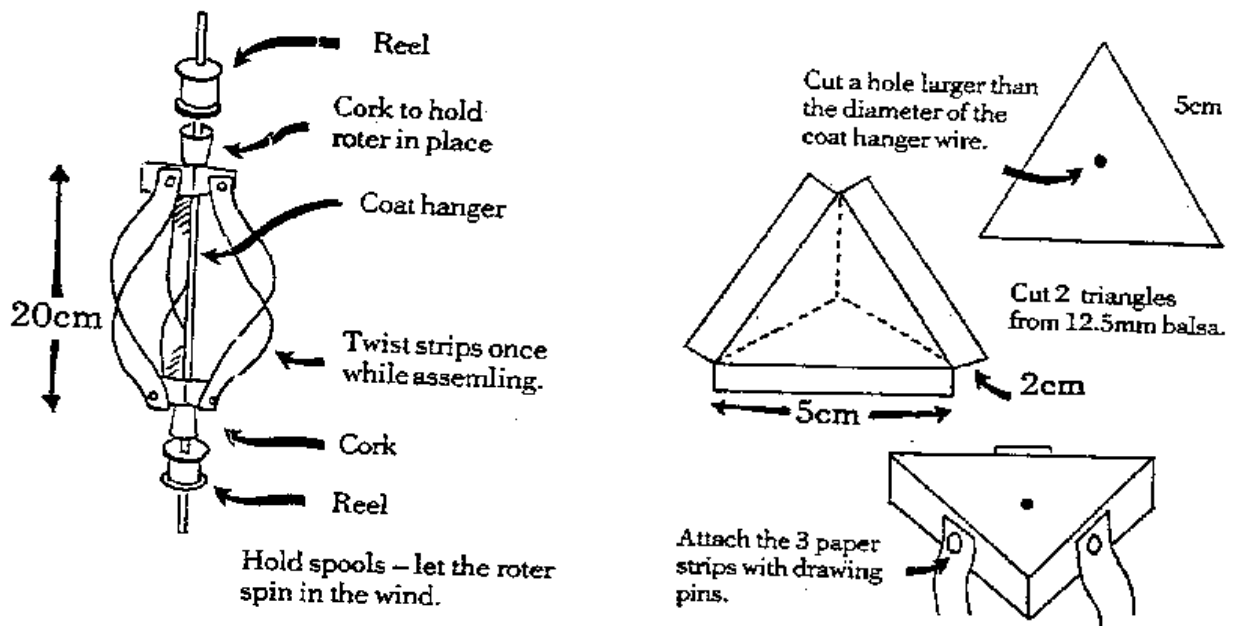

SOLAR ENERGY

Project #1: How does a solar box cooker work?

Project #2: What is the quality, quantity, and distribution of the sun's energy?

Project #3: What are solar concentrators and how do they work?

Project #4: Photovoltaics

SOLAR ENERGY

The sun is a tremendous emitter of energy. Most of the energy is in the form of light and heat, which can be collected and used for generating electricity, as well as for heating, cooling and lighting building.

Photovoltaic Conversion Photovoltaic (solar) cells are large-area semiconductors that convert sunlight directly into electricity. Most of us have seen photographs of photovoltaics on roofs or on the ground near homes and buildings. Photovoltaics can meet virtually any electric power need and are used for numerous applications including watches, calculators, satellites, telecommunications, homes, schools, factories and businesses. Because of the cost, photovoltaic systems are not widely used, but advancements in efficiency and cost reduction should make photovoltaics economically competitive with traditional power sources by the end of the decade.

Solar Thermal Systems Solar thermal systems convert the energy in sunlight to heat by using concentrations such as mirrors to focus sunlight onto a receiver. The receiver contains a fluid that absorbs the heat. The heat is then used to generate electricity or to warm buildings, dry agricultural products or destroy harmful wastes. Solar thermal systems use three different types of concentrators -central receivers, parabolic dishes, and parabolic troughs. *Central receiver systems* use heliostats (highly reflective mirrors) that track the sun and reflect it to a central receiver atop a tower. *Parabolic dish systems* use dish-shaped reflectors to concentrate and reflect sunlight onto a receiver mounted above the dish at its focal point. *Parabolic trough systems* use parabolic reflectors in a trough configuration and are the most mature solar thermal technology .

Solar Heating, Cooling and Lighting Energy from the sun is also used to heat, cool, and light buildings. Buildings are heated and cooled with active and passive systems. Active systems rely on mechanical components to collect and deliver heat. For example, active solar water heaters use electrically powered pumps and valves to control the movement of warmed water. In contrast, passive systems use few mechanical components, relying instead on design features, gravity and natural ventilation to heat and cool homes and buildings. Design features such as an atrium or high windows that allow more sunlight to reach the interior reduce the need for electric lighting.

PROJECT #1 HOW DOES A SOLAR BOX COOKER WORK?

Materials You will need 2 large corrugated cardboard boxes with flaps -one fitting inside the other with about 5 cm between them on all sides and bottoms (inner box should be at least 46 x 56 cm); a flat piece of cardboard about 20 cm longer and wider than the larger box, a light piece of glass or Plexiglas about 50 x 60 cm, a thin metal tray painted black about 42 x 52 cm, dark cooking pots, aluminum foil, water- based glue, lots of newspaper for insulation, string (1 foot long), a stick (about 1 foot in length).

Procedure Build the solar box cooker by the directions in Appendix 1.

Ideas to Study

1. Investigate various kinds of insulation in your solar cooker.
2. Investigate the cooker at different times during the school year to determine when it takes the longest or shortest time to cook.
3. Design, build and test your solar box cooker.

PROJECT # 2 WHAT IS THE QUALITY , QUANTITY , AND DISTRIBUTION OF THE SUN'S ENERGY?

A. How much solar radiation is available?

Equipment Low-cost pyranometer and recorder

Resources LI-COR, Inc. (402) 467-3576 (Model LI-1200S Minimum Data Set Recording System). *Insolation Data Manual and Direct Nonnal Solar Radiation Data Manual* 91990, SERm"P-320-3880, Golden, CO: National Renewable Energy Laboratory) has data summaries for numerous U.S. cities.

Ideas to Study

1. Using the pyranometer system compare measurements with cloud observations (clear day, partly cloudy, overcast, etc.) Compare observations with printed data summaries of the 30-yr means. There are a number of variable to consider in your study: days of year (hours of daylight), orientation of radiometer (horizontal, tilt angle, azimuth angle), sky conditions.
2. Determine the connection between weather variable, such as temperature, relative humidity, and cloudiness, and the changes in available solar energy .
3. Determine if your pattern of solar radiation through the day (or year) matches the need for air conditioning, heating, cooking, and hot water in your home?

B. Does air pollution affect the amount of light from different portions of the solar spectrum that reaches Earth's surface?

Equipment Solar cells, light filters (red and blue gelatin), milliammeter (0-50), or resistors and a voltmeter (0-10 volts).

Hint Use the solar cell's output as measured with the ammeter or voltmeter and various resistors. Measure solar energy at the same sun elevation on different days. Air pollution data are available from the EPA.

Ideas to Study

1. Compare direct sun with full sky radiation (see diagram).
2. Sort out the variables and determine the effects of different kinds of air pollution on different light wavelengths.
3. Investigate if the amount of solar energy reaching Earth is affected by air pollution.

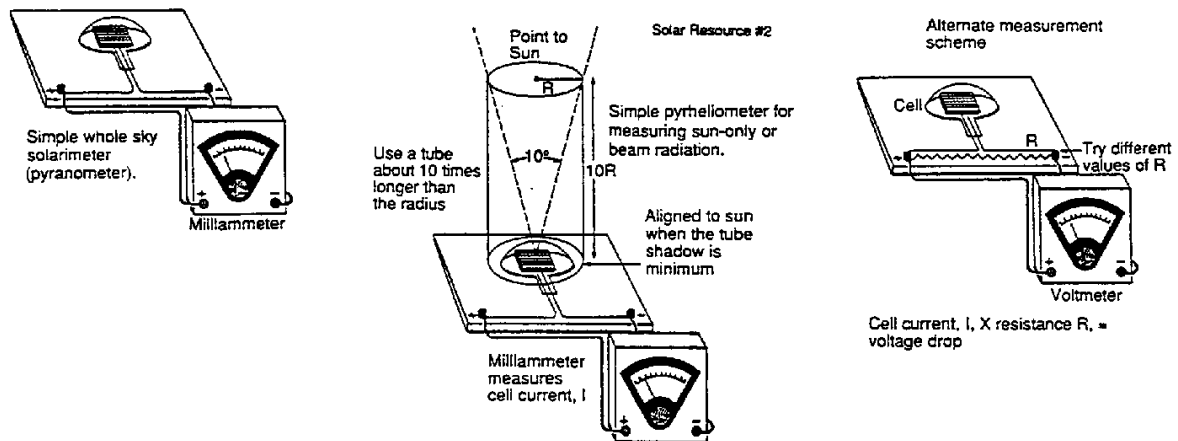

PROJECT #3 WHAT ARE SOLAR CONCENTRATORS AND HOW DO THEY WORK?

Resources Norton, T.W., D.C. Hunter and R.J. Cheng, 1977. *Solar Energy Experiments for High School and College Students*. Emmaus, PA: Rodale Press.
Solar Energy Industries Association. 777 N. Capitol Street NE, Washington, DC 20002, (202) 408-0660.

Ideas to Study

1. Design and construct a parabolic reflector. This project requires a knowledge of algebra. Draw 3 parabolic curves using equation of a parabola [$y=nx^2$]. Let $n = -10, 1,$ and $1/2$. Calculate x and y for at least 6 data points. Discuss what happens to the focal length [$f = x^2/4y$] as the curve flattens out (that is, as n approaches zero). How does the shape of the parabola and its focal point determine the area in which the reflected light reaches maximum concentration.

2. Design a parabola of reasonable size (no longer than you can build or carry) using the equations $y = nx^2$ and $F = x^2/4y$. Graph the parabola on regular graph paper until you are sure of your design. Transfer the design onto a large piece of sturdy corrugated cardboard. Cut out the parabola. To make the reflector, glue aluminum foil to flexible tagboard and smooth it with a squeegee until it is mirror-like. Attach the reflector to the cardboard parabola securely. Test the parabolic reflector in the sun. Locate the focal point with your hand. Be careful not to get burned. Do not look at the sun. Measure the focal length and see if it agrees with your calculations. Analyze the effect of tracking the sun on cooking time. If you do not want to spend time designing a solar concentrator you can use the design shown below and test its effectiveness in cooking a hot dog. Make the parabolic trough out of cardboard, poster board, aluminum foil, unpainted coat hanger two boxes (one for the concentrator and one for a stand), nuts and bolts.

Specific Resources: Williams, J. 1981, "Building Solar Furnaces- An Example of Science in a Primary School," *School Science Review*. Vol. 63, No. 223. pp. 267-76.

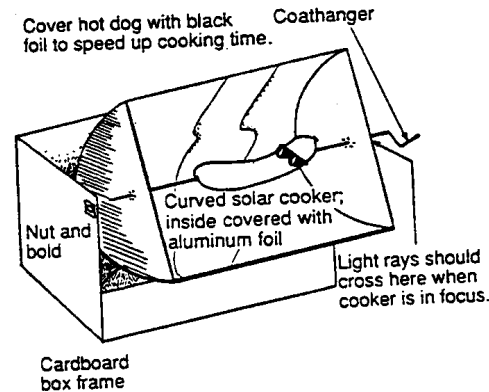
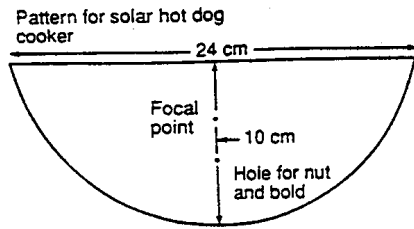

3. Investigate the advantage of a collector that tracks the sun. You will need any movable solar collector or concentrator, thermometer or thermocouple. Determine the temperature in the center of a piece of black construction paper when it is flat (perpendicular) to the sun's rays and when it is tipped at an angle to the sun. Determine the performance of a higher performing collector when it is oriented toward the sun. How much energy is collected during the day if the collector is laid flat on the ground, tipped up at various angles, or continuously pointed at the sun?

4. Investigate what materials are best for absorbing sunlight and converting it to heat? You will need materials made of steel, copper, plastic, color, and thermometer. Place different types and colors of materials on the ground in sunlight. Place thermometers on each one. Be careful to cover the bulb of the thermometer with the same color or type of material, can carefully tape the thermometer to the sample. Record temperature versus time. What effect does insulation or glazing or both have on results? Is a smooth surface better than a glossy surface? What about different kinds of paint? Try putting food coloring into ice cubes and timing the rate of melting in sunlight.

Specific Resources: Davis, D., 1979. *Solar Energy Laboratory Manual*. Aspen, CO: Crystal Productions Company.

5. Investigate the effect of size on the amount of heat a flat plate collector can absorb? Paint aluminum pie pans of different sizes with flat black paint. Add 100 mL of water to each pan. Measure water temperatures at the start and every 15 minutes. What effect is caused by covering the pans with plastic wrap? Try heating the water to the same temperature using a candle and compare the time and cost.

Specific Resources: Ely, J. and K. Ford, October 1989. "Sizing Up Solar Energy." *Science and Children*, pp. 14-15.

6. Build a flat plate solar water heater. You will need 1/2 in or 3/8 in copper tubing (50 cm), plastic tubing or hose that will fit over the end of the copper tubing, cardboard box, plastic cover, thermometer, two buckets, and a clothespin. Bend the tubing into an "S" shape, being careful not to kink it (a tube bender helps but is not necessary). Paint the tubing with flat black paint and place it in a cardboard box with the ends extending through holes in the box. Create a siphon by placing one end of one piece of the plastic tubing over one end of the copper and the other end in a bucket of water. Use the other piece of plastic tubing to connect the outlet of the copper to another bucket. Use a clothespin to control flow.

Cover the box with plastic and set it in the sun. Measure the inlet and outlet water temperatures. Study the number of turns of copper tubing.

7. Investigate what collector (non-concentrating) designs work best for heating air. You will need thermometers, fan, empty aluminum or steel cans, wood or cardboard box. Make a simple air heater from a cardboard box. Paint the inside black and cover with plastic. Make two holes diagonally (at opposite corners). Use a small fan to blow air through the collector or just let the warm air flow out of the upper hole. Measure air temperatures at the inlet and outlet. You can also measure the airflow rate. Cut cans in half, paint them black, and attach them to the bottom of the box to improve heat transfer to the air. Try insulation. Balance the cost of materials, construction time, and durability against performance.

8. Investigate how a solar still works. You will need a large pan or tub, clear plastic food wrap, rock, masking tape or rubber bands, drinking cup or glass. Make some muddy water and measure enough into a pan to fill it about half way. place the drinking cup in the middle. Cover the pan with plastic wrap and seal the edges carefully. Put a rock on the plastic wrap to make it sag in the middle (but don't let the plastic touch the cup). As the water evaporates, notice the tiny drops that condense on the cool plastic. How much water collected in the glass? How much water was lost from the pan? You can also study using salt water instead of muddy water. Try insulating the pan or blowing a fan over the top of the plastic. Calculate how large a still would be needed for all the water you drink during the day. Design a more efficient still.

Specific Resources: (1) *How to Make a Solar still Plastic Covered*. 1973. "Do-It-Yourself" leaflet L-1. Available from Brace Research Institute. MacDonald College of McGill University .Ste. Anne De Bellevue. Quebec. Canada 49X 3M1. \$1. (2) Talbert. S.G., J.B. Etbling. and G.O.G. LOr. 1970. *Manual on Solar Distillation of Saline Water*. Available from U.S. Government Printing Office.

Superintendent of Documents. Washington, DC 20402. (3) *Simple Solar Still for Production of Distilled Water*. Technical Report No. T17. Available from Brace Research Institute (address above). \$1.

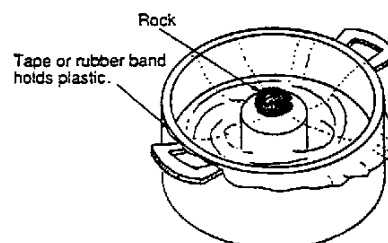

You may have to put a weight in the cup to keep it from floating.

9. Make a solar dehydrator. You will need grapes, plastic window screen, cardboard, masking tape, string, food scale.

Make a drying rack by taping plastic screen over a 15 cm X 15 cm hole cut into a piece of cardboard and using string to hang the rack in the sunshine. Or build an oven like the one in the drawing. Remove about 12 grapes from a bunch, weigh them, and spread them on the screen. Cover with a second layer of screen and hang the dehydrator in the sun. When the grapes look like raisins, take them off the rack and weight them again. Try drying other fruits such as peaches, apples, and bananas. Compare the cost of fruit brought fresh and dried in the sun to the cost of dried fruit. make a dehydrator that has two or more shelves and uses solar heat.

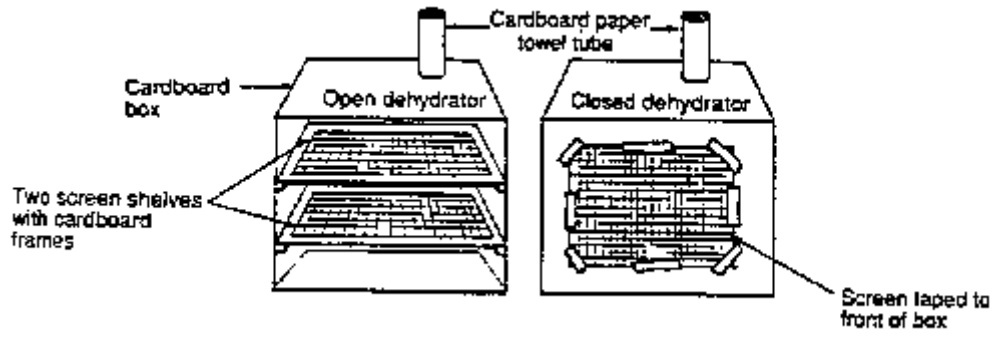

PROJECT #4 PHOTOVOLTAICS

HOW TO BUILD A SOLAR BOX COOKER

1. **Glue foil on the cardboard.** Dilute the water-based glue in a bowl, so that it will last a long time and you can brush-apply it. Glue foil completely over: (a) the inside *and* outside of the smaller box (cut off the flaps), (b) the inside of the larger box, (c) the inside *and* outside of the larger box's flaps, and (d) one side of the flat cardboard piece

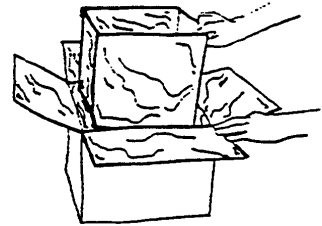

2. **Add bottom supports and insulation.** Cut out 4 cm squares from the discarded larger box flaps. Glue them on top of each other to form eight 2-3 cm high pillars. Glue these pillars inside the bottom of the bigger box to support the inner box. Tear up newspaper sheets in fourths and crumple each piece into a lemon-sized ball. Cover the bottom of the bigger box with these balls.

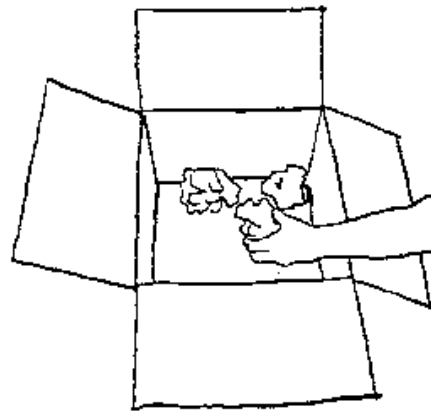
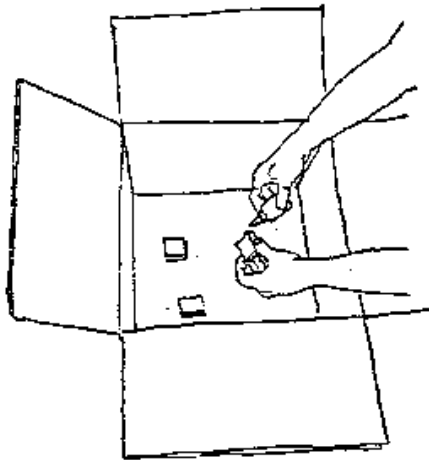
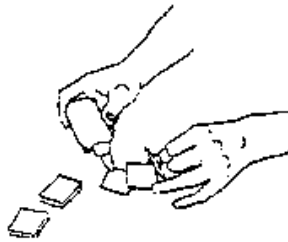

HOW TO BUILD A SOLAR BOX COOKER

3. Add inner box and side insulation. Place smaller box inside the larger box. Stuff more newspaper balls between sides of boxes.

4. Cut the flaps of the outer box so that they fit in the inner box. Cut them so that they can be folded over, covering the top space between the boxes as well as the inner wall of the inner box (see diagram). Fold the flaps over and glue them.

5. Put the black tray in the box. Paint it black if it isn't already. Use nontoxic paint.

6. Make the lid. Take the flat cardboard piece and center it, foil facing down, on top of the box. Fold down what sticks over the edges of the large box. You need to make four cuts in the cardboard to do this. Then, glue the folded edges of the lid together (not to the box). Make sure the lid fits snugly on the box.

7. Glue the glass to the lid. Cut 3 sides of a rectangle in the lid. This rectangle should be slightly smaller than the glass. Turn the lid over and glue the glass, around its edges, to the inside of the lid. Press it flat until the glue dries. If you use plastic wrap, stretch it out around the rectangular opening and tape in around the sides.

8. Make a prop. Bend up the cut-out rectangle in the lid so that it can reflect sunlight into the cooker. Attach a stick with string to the corner of the reflector and the side of the lid. If it is windy, you may want a prop on both sides.

**You are now finished with your solar box cooker
and are ready to cook!**

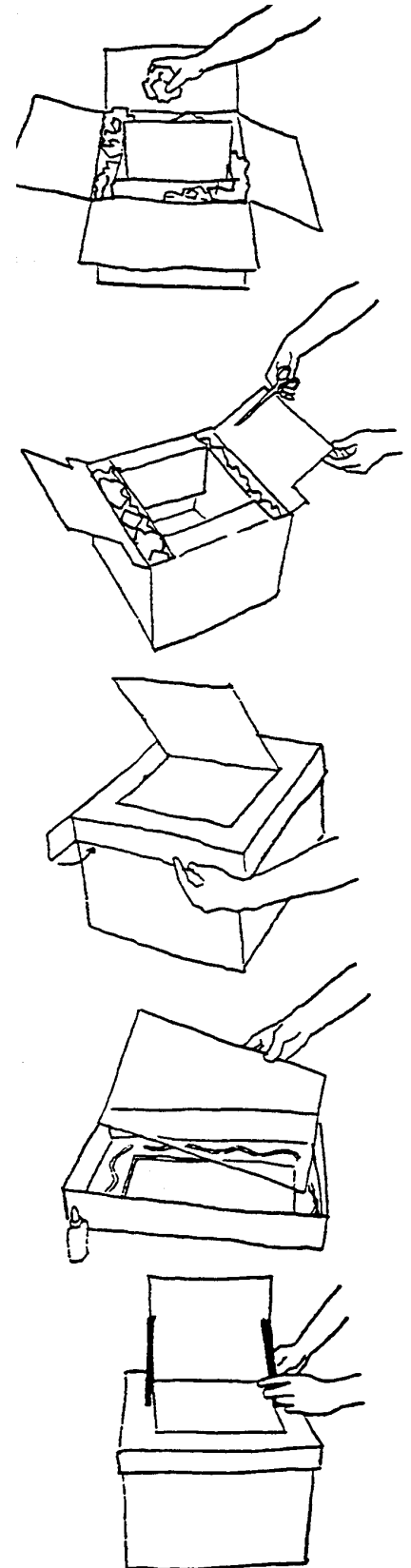

Solar Box Cooker: Guidelines for Cooking Food – Teacher Information

1. Put your food in covered black pots in the solar box cooker with the lid on.
- 2 Aim the box so the shiny side of the lid reflector faces where the sun will be in late morning (lunch) or early afternoon (supper). Tie the prop to hold the lid reflector where it shines the most sunlight into the box.
3. Warning: Temperatures inside the cooker can reach 275 degrees Fahrenheit. Do not leave cooker unattended in a place where it could be disturbed by other students.
4. Food cooks better:
 - on a warm, sunny day in late spring, summer, or early fall
 - if you put it towards the back of the box
 - if you adjust the cooker often so that its shadow lies directly behind it
 - if you divide the food up into small pots
5. You need not stir the food while it is cooking. If you open the box during cooking, be careful of the high temperatures inside.
6. Most of all, put the food in early, and don't worry about overcooking-solar cookers seldom overcook. Cooking times for recommended foods are:
 - 1-2 hours: rice, fruit, above-ground vegetables, pretzels
 - 3-4 hours: potatoes, root vegetables, some beans (including lentils), most bread
 - 5-8 hours: most dried beans

RUBRIC FOR TASK ASSESSMENTS

Rubric for Task Assessments

Research Projects in Renewable Energy for High School Students

General Scale for Scoring Student Performance

SCORE	DESCRIPTION
5	Beyond expectations—quality of work is unusually high and beyond expectations
4	Meets expectation—skill is mastered to the level of expectation
3	Almost there—skill is almost mastered but with minor problems
2	The skill is present but with errors and omissions
1	The skill is absent